

Caution

Please Carefully Read This First

1. Any components of the product cannot be submerged in water and exposed in the rain, which could cause a battery explosion and display unit damage.

2. when stored for a long time, the equipment should be stored in dry environment and used the original packing seal.

Environmental temperature: 32~122°F and the relative humidity: 20%~85%

Applicable Standards

Standards and Guidelines applied: ISO 18625 (2003), ASTM A956 (2006), DIN 50156 (2007), JIS B7731 (2000), JB/T 9378 (2001)

1. Summarize

1.1 Measuring Principle Scope

When the test is carried out, an impact body with a tungsten carbide test tip is impelled by spring force against a test surface from which it rebounds. Impact and rebound velocities are measured by following method: a permanent magnet integrated into the impact body passes through a coil and induces an electric voltage during its forward and return travel. These voltages are proportional to the

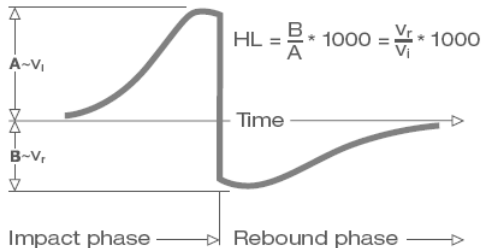

Fig. 1-1

velocities and are processed and displayed as the hardness value L on the indicating device.

Modern electronics with power saving features provide for long operating life. The large LCD display always shows how the **SHPMHT136** is configured to test. Variable function keys allow for quick change of common test parameters. No subjective measuring errors are possible, giving highly repeatable results. Internal self diagnostics with error messages assure reliable test results. Readings can be stored automatically in the internal memory or sent directly to a printer. PC evaluation software allows for data analysis. These conversions to other scales (HRC, HRB, HB, HV, HSD etc.) are programmed into the electronics and can be shown directly on the display as the test result.

1.2 The Hardness Value "L"

This term, 1978 introduced by Doctor Dietmar Leeb into measuring technology, is the quotient for the impact body's rebound and impact velocity, multiplied by 1000. Harder materials produce higher rebound velocity than those which are less hard. With reference to a particular material group (e.g. steel, aluminum etc.), the L-value represents a direct hardness measurement and is used as such.

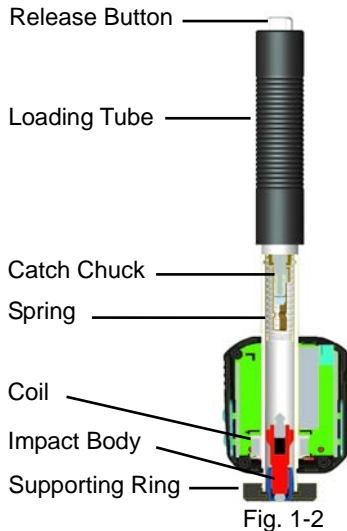

Comparison curves with standard static hardness values have been established (Brinell, Vickers, Rockwell C, B, Shore D) for the most prevalent materials, enabling the L-value to be converted into the relevant values for these procedures.

With **Shimada SHPMHT136**, such hardness values can be directly displayed in the hardness scales HLD, HRC, HRB, HB, HV, HSD.

1.3 Features

- The most advanced integrated tester (Impact Device D integrated):
no cables
- Integrated impact direction sensor
- Highly accuracy ($\pm 6\text{HL}$) in any impact direction (360°) –
automatically
- Integrated display of results for all common hardness scales
- Large, high contrast LCD for optimum viewing in all conditions
- Easy calibration
- Full USB communication with PC, software included free of charge
- Internal storage of data with day and time
- Rechargeable Li-ion battery, charges through USB port
- Intelligent sleep mode
- Wireless (Bluetooth) mini printer

1.4 Applications

- Good for all materials
- Best suited for on-site testing of heavy, big or already installed parts
- Handy for difficult to access or confined test locations
- Automatic sensing and compensation for impact direction
- Excellent for material selection and acceptance tests

1.5 Primary Industries

- Metal production & processing
- Automotive & transportation
- Machinery & power plants
- Petro-chemical, refineries
- Aerospace & shipyard
- Metal constructions testing services & laboratories

2. Technical Specifications

- Indication range: 0~999HLD
- Accuracy: ± 6 HLD
- Measuring direction: Any direction
- LCD display: 128 x 64 dot LCD with backlight
- Data memory: 500 groups
- Measurement results can be automatically converted into: HB, HRB, HRC, HV, HSD
- Impact energy: 11N
- Mass of the impact body: 5.5g
- Impact tip:
 - Material: tungsten carbide
 - Diameter: 3mm

Hardness: $\geq 1600\text{HV}$

- Power: Li-ion rechargeable battery
- Charger: DC 5V/500mA or USB port
- Maximum continuous working time: approx. 16 hours
- Operating environment: Temperature: 32~122°F
Humidity: 20%~85%
- Storage environment: Temperature: 14~+144°F
Humidity: 5%~95%.
- Dimensions: 146 x 35 x 22 mm
- Weight: 66 g

3. Overview

Ref. Fig.3-1



Fig. 3-1

4. Checking Supplied Accessories

Make sure you have each items and you can obtain various accessories from your local distributor. (Fig. 4-1)

The items are supplied with your hardness tester and the accessories available at your distributor may vary, depending on your country or service provider.

Use the purchased accessories with only authorized devices. The use of these accessories with other devices could cause problems and any repair costs would not be covered by the warranty.

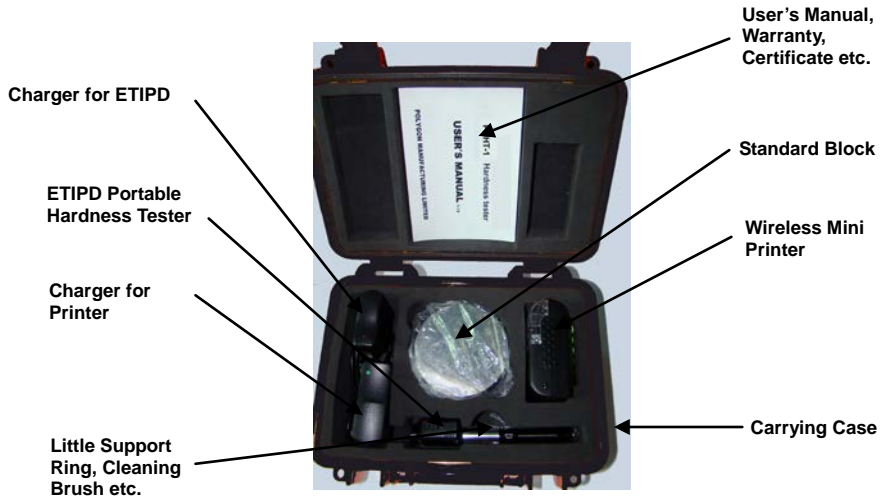

Fig. 4-1

Packing List

















No.	Description	QTY.
1	Carrying Case	1
2	SHPMHT136 Metal Hardness Tester	1
3	Standard Block	1
4	Wireless Mini Printer	1
5	PC Software	1
6	USB Cable	1
7	Battery for Printer	1
8	Charger for SHPMHT136	1
9	Charger for Printer	1
10	Little Support Ring	1
11	Cleaning Brush	1
12	User's Manual	1
13	Certificate	1
14	Warranty	1

5. Operating Instructions





5.1 Keys and Function (Fig. 5-1)



Fig. 5-1

1. "  ": **Next**, you can use the key to select material, scale etc ;
2. "  ": **Menu & Select**;
3. "  ": **Print**;
4. "  ": **ON/OFF & Back**;
5. "  " + "  ": **Hardness Calibration**; press and hold "  " , then press "  " for two seconds to display the calibration mode;
6. "  " + "  ": **Delete**; press and hold "  " , then press "  " to delete the current data;
7. "  " + "  ": **Set the date and time**; In shutdown state, press and hold "  " , then press "  " to set the date and

time;

8. "  " + "  ": **Data Browse**; press and hold "  ", then press "  " to enter data browse.

5.2 LCD Screen

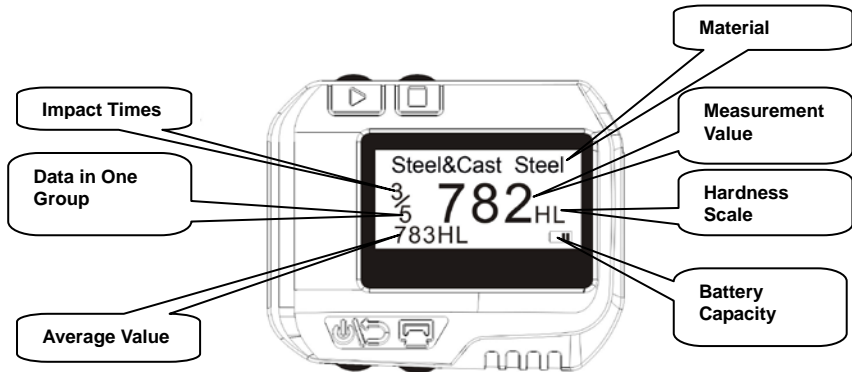

Fig.5-2

5. 3 Setting

5.3.1 Material Type

In measurement mode, press "□" three times once, the material character will highlight, then press "▶" to select the Material Type; the material type changed according to following sequence:

Steel & Cast steel → **Alloy**

Tool Steel → **Stainless**

Steel → **Grey Cast Iron**



Fig.5-3

→Ductile Iron →Cast Aluminum Alloys →Brass →Bronze
→Copper →Forging Steel →Steel & Cast steel →....

Note:

1. It is necessary to select the material classification. When you did not know the material type, you must refer the related material handbook.
2. When you change the material group, the Impact Times counter will be set to "0".

5.3.2 Hardness Scale

In measure mode, press "□" twice, the hardness scale



Fig.5-4

character will highlight, then press "▶" to select the hardness scale; the hardness scale changed according to following sequence:

HLD→HB→HRB→HRC→HV→HSD→HLD....

HB	Brinell
HRB	Rockwell
HRC	Rockwell
HV	Vickers
HSD	Shore (D)

Note:

- 1. The value "----" means out of range.**
- 2. The default hardness scale is HLD.**





Fig. 5-5

5.3.3 Data in One Group

In measurement mode, press " " four times, the **data in one group** character will highlight, then press " " to set the number, the maximum number is 9.

5.3.4 Browse Data

① Browse the data in current group: in measurement mode, press " " once, the **impact time** character will highlight, then press " ", you can browse the data in current group. (Fig.5-6)

② Browse the historical data:



Fig.5-6

in measurement mode, press and hold "□", then press "▶" to display the historical data browse mode (Fig.5-7), press "▶" to select

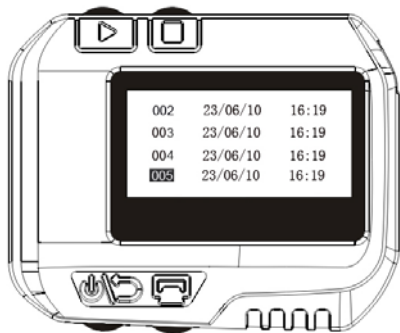

Fig.5-7



Fig.5-8

the next group, press " □ " to select the previous group; press " □ " you can browse the data that you selected (Fig.5-8); press " ▷ " to browse the data in the current group.

Press " ⏪ " will return to previous menu.

5.3.5 Setting the Date and Time

SHPMHT136 has built-in real-time clock, It must be adjusted the clock and the calendar when it is necessary.

Please as follows:



Fig. 5-9

In shutdown mode, press and hold "▶", then press and hold "⏻" for about three seconds to the date and time setting mode. Press "□" to increase the "day" from 1 to 31, press "▶" to decrease the "day" from 31 to 1; press "◀" to set the month, press "□" to increase the "month" from 1 to 12, press "▶" to decrease the "month" from 12 to 1; use the same way to set the year, hour, minute and second. In the "**second**" set-up process, press the "⏻" will finish the setting and back to measurement mode. (Fig. 5-9)

5.3.6 Calibration

Calibration is used to calibrate the measured value (HLD) of the hardness tester, so as to farthest decrease the measuring error, please as follows:



① In shutdown mode, press and hold "  ', then press and hold "  ' for about three seconds to display the calibration mode (Fig. 5-10),





Fig.5-10





Fig.5-11



then test five times on the test block and get the average of measurements value.

② Press "  ' to browse 5 data test, you can press "  " to delete the error data.

③ Press "  ' to display the mode like (Fig. 5-11), the "hundred" bit will be highlighted, input the HLD value that marked on test block.

④ Press "  ' to increase from 0 to 9, to set the "hundred" bit.

⑤ Press the "  ' the "ten" bit will be highlighted, Press "  ' to increase from 0 to 9, to set the "ten" bit (Fig.5-12).

⑥ Press the "  ' the "last" bit will be highlighted, Press "  ' to increase from 0 to 9, to set the "last" bit (Fig.5-13).

⑦ Press "  ' to return to the measurement mode, the calibration is finish.

Note:

- 1. You must calibrate it on the test block before you first use the hardness tester.**
- 2. The impact direction must be down straight.**



Fig.5-12



Fig.5-13

5.4 The Format of Memory Data

The data (such as hardness value, scale, sample material and impact direction, time, date etc.) will be saved in memory automatically after one individual impact. **SHPMHT136** can store 500 data, when test times are more than 500, the last data will be stored in the 1th position and the first data will be erased, simultaneously the position of other data will be moved into lower position.

5.5 Backlight

LED backlight is used for poor light conditions. If there is no impact, or not press any key in 3 seconds, the backlight will be turn off automatically, when testing or press any key, the backlight will turn on automatically.

5.6 Automatic Shutdown

If there is no measure, and no key operation in 3 minutes, display unit will automatically switch off in order to saving battery power. Display unit will automatically store all the parameters before turning-off.

5.7 Charging

Users need to recharge batteries when batteries are used for the first time and exhaustion of electricity arises.

Firstly, users should connect the

SHPMHT136 and the charger use the USB cable (Fig 5-14), and then connect the charger with AC socket to start charging.

Meanwhile, the screen will display in charging mode. (Fig 5-15).



Fig.5-14

You can also use other USB device (e.g. Laptop) to charge **SHPMHT136**.

The charging time: 2~3 hours. Fig 5-16 shows the charging is finish.

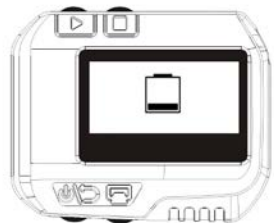

Fig.5-15



Fig.5-16

5.8 Full Screen Mode

In measuring interface, press "▶" key to full screen measurement information for the user to read out information clearly, press "↻" key to return to measurement interface or Automatic return without 2 s.

Fig 5-16 & 5-17



Fig 5-16



Fig 5-17

6. Data Printing

SHPMHT136 can be linked with exclusive Bluetooth mini printer, so printer can print out the measured values. The maximum distance between the **SHPMHT136** and the printer is three meters.

When the printer is turned on, press "  " will print out the current data.



Fig.6-1

A complete test report is shown at Fig. 6-2.

```
-----  
Test Report  
-----  
Impact Unit Type: D  
Material : Steel&Caststeel  
1  808 HLD  ↓  61.2 HRC  
Date: 06/07/31 Time:18:21:27  
2  808 HLD  ↓  61.2 HRC  
Date: 06/07/31 Time:18:21:27  
3  805 HLD  ↓  60.8 HRC  
Date: 06/07/31 Time:18:21:27  
4  808 HLD  ↓  61.2 HRC  
Date: 06/07/31 Time:18:21:27  
5  805 HLD  ↓  60.8 HRC  
Date: 06/07/31 Time:18:21:27  
-----  
s = 3  HLD    00.4 HRC  
 $\bar{x}$  = 806 HLD    61.0 HRC  
Printed: 06/07/31    18:21:27  
-----
```

7. Hardness Test

7.1 Setting the Tester

Press "  " to turn on, and check if it's need to charge. Inspect if every setting of is correctly, particularly the material type and scale. The setting inconsistent with the actual condition may cause a great error.

7.2 Sample Preparation

Inappropriate sample will cause a great measurement error. Therefore, users should make the necessary handling and preparation under the

original conditions of sample.

Preparation of the sample and the surface of test should be coincident with the following basic requirements:

- 1) During the process of sample surface preparation, users should avoid the impacts of cold processing and thermal processing.
- 2) The sample surface is plane for better, the test surface should be with a metallic sheen, and not involve oxide layer or other stains.
- 3) Roughness of the test surface $Ra \leq 1.6$.
- 4) Sample must be of sufficient quality and rigidity. If it's lack of quality and rigidity, it may cause displacement or shaking in the process of testing impact, which can lead to large errors.

Generally speaking, if the sample quality is more than 5kg can be directly tested; if the sample quality is 2~5kgs, the sample should be

taken in fixation test by means of appropriate clamping; if the sample quality is 0.05~2kgs, the sample should be conducted coupling before the test; if the sample quality is less than 0.05kg, this hardness tester is inappropriate to use.

Coupling method: Testing sample's back should be prepared to make a plane as a supporting surface with a smooth formation.

Filling with a little coupling substance (Industry Vaseline can be used), users can now press to the surface of the supporting object (The weight of supporting object should be more than 5 kg, and it can be replaced by test block) to stick into integration.

- 5) Samples should be thick enough and with sufficient surface absorption layered. The thickness of sample should not be less than 5mm, and surface absorption layer (or surface-hardening layer)

should not be less than 0.8mm. To accurately measure the hardness of the material, the best way is to remove the surface-hardening layer by processing.

- 6) When testing sample surface is not horizontal, the curvature radius of testing and nearby surface should be larger than 30mm, and appropriate supporting ring should be elected and installed.
- 7) A sample should not be with magnetic; otherwise the signal of the impact device would be seriously interfered by the magnetic, which may cause inaccurate test results.

7.3 Test Steps

1) Loading

Simply load **SHPMHT136** by sliding the



Fig.7-1

loading tube forward. (Fig.7-1)

2) Place

Then place and hold **SHPMHT136** on the surface of the test piece at the desired test point. Impact indirection should be vertical with the test of surface. (Fig.7-2)

3) Impact (Measure)

Trigger the impact by pressing the release button. The hardness value will be instantaneously displayed. (Fig.7-3)



Fig.7-2



Fig.7-3

4) Read off the test result

Read off the test result from LCD at Fig.7-4.

Modern electronics with power saving features provide for long operating life. The large LCD display always shows how the **SHPMHT136** is configured to test. Variable function keys allow for quick change of common test parameters.

No subjective measuring errors are possible, giving highly repeatable results. Internal self diagnostics with error messages assure reliable



Fig.7-4

test results. Readings can be stored automatically in the internal memory or sent directly to a printer. PC evaluation software allows for data analysis.

8. Troubles and Solutions

No.	Trouble	Reasons	Solutions
1	No response switched	Lack power	Charge the battery
2	Abnormally high results	Test tip wearing	Replace the test tip
3	No test results	Coil damage	Contact agencies
4	Printer no response	Beyond the transmission range	In the 3 meters
* Other Trouble, please contact with agencies or distributor.			

9. Maintenance and Service

9.1 Impact Device Maintenance

After using 1000-2000 times, users should clean the catheter of impact device and impact body with nylon brush, and screw off the supporting ring before clean the catheter, and then take out the impact body, rotate the nylon brush into the tube in an anti-clockwise direction, and pull out when touching the bottom. So repeatedly, and then load up the impact body and supporting ring; Users should release the impact body after use. And the lubricant is banned.

9.2 Store the Report

Because printing paper is thermal paper, it should be preserved to avoid the heat and direct light. If the print records are necessary to be

kept in long-term preservation, please copy and preserve in time.

9.3 Normal Maintenance Procedures

In calibration of the hardness tester, if finding that error is larger than 12HLD, you must be replace the impact ball or impact body, because the reason may be that the impact ball or impact body is wore out to lead to failure in operation.

When the hardness tester arises other abnormal phenomena, you should not demolish or adjust any fixed assembly parts, instead, they should complete warranty cards, send them to authorized maintenance department for maintenance.

Appendix 1 Daily Checking

Normal test block is mainly used for calibrate the hardness tester. The error and the repeatability of the hardness tester should be in the scope defined by the following table.

Impact Direction	Hardness of Test Block (HL)	Error Allowed	Repeatability Allowed
	750~830	±12HLD	12HLD
	490~570	±12HLD	12HLD

Note:

1. Error= $\overline{\text{HLD}}-\text{HLD}$

HLD is the average value of 5 values measured on the test block.

HLD is the value that marked on test block.

2. Repeatability= $\text{HLD}_{\text{max}}-\text{HLD}_{\text{min}}$

HLD_{max} is the maximum value in 5 values that measured on the test

block.

HLD_{\min} is the minimum value in 5 value measured on the test block.

Appendix 2 Factors that Affect Accuracy

Incorrect operation or improper testing conditions would have serious impact on testing accuracy. Following is several common factors affect the accuracy of testing in use for reference:

1) **Roughness of sample surface**

When the impact body impact on the sample, a small pit would arise on the sample surface, so at the same time, should finish the surface of the sample. The more roughness, the less consumption of impact energy whereas the less roughness, the more consumption of impact energy. Accordingly, the roughness of sample testing points on the surface $Ra \leq 1.6$.

2) The shape of sample surface

Leeb testing principle demands the velocity of rebound and impact are on the same line, because the impact body is moving in a metal tube. Even if the velocity of rebound and impact are not on the same line, it also can show hardness for sure, but the impact body would collide with tube wall when it rebounds, which will affect the velocity of rebound. Therefore, a greater error is on test accuracy. When the radius of curvature of the testing sample surface is smaller, the solution is the use of suitable variant supporting circle. If users require special supporting circle, we can contribute to design and process.

3) The weight of the sample

If the sample weight must be larger than or equal to 5kg, and not easily sway. If the sample weight were less, the sample would need proper

treatment (It is necessary to increase the supporting or mounting through coupling compress on larger weight testing stand), and the testing results can be achieved in accuracy. There should be a certain area at the testing points (the area required to meet a set of testing points) and no vibration or shaking. If the weight is not enough, users must be as much as possible reduce the jitter and sloshing by the methods of increasing supporting, coupling and compressing. And supporting device should avoid shock.

4) The sample stability

Any effective tests need to minimize possible interference from outside; it's more important to dynamic measure such as Leeb hardness test. Therefore, measuring only allowed in stable hardness testing system. If it's likely to lead to sample movement in the tests, users should fix it before testing.

Appendix 3 Measuring Range

Materials	HV	HB	HRC	HRB	HSD
Steel & Cast Steel	81-955	81-654	20.0-68.4	38.4-99.5	32.5-99.5
Alloy Tool Steel	80-898		20.4-67.1		
Stainless Steel	85-802	85-655	19.6-62.4	46.5-101.7	
Grey Cast Iron		63-336			
Ductile Iron		140-387			
Cast Aluminum Alloys		19-164		23.8-84.6	
Cu-Zn Alloys (Brass)		40-173		13.5-95.3	
Cu-Sn Alloys (Bronze)		60-290			
Copper		45-315			
Forging Steel	83-976	142-651	19.8-68.5	59.6-99.6	26.4-99.5

For more info please visit
<http://www.hardness-testers.ca/portable-hardness-testers/all-in-one-portable-hardness-tester.htm>